

| | | | |
|---|---------------------------------|---|----------------|
| | | | |
| | 2020-32135 -24-03-512161 | | |
| | | | 13 14 55031 |
| | 1 | | |
| | <u>11 4 13.772 34 05 20.1 3</u> | | |
| | 2452 | | 2 2 |
| | | | |
| / | | / | 2020 2 |
| | 10000 | | 2 |
| % | 0.2 | | |
| | | 2 | 43606.72 65.14 |
| | | | |
| | 2015-2030 | | |
| | 2015 1 | | |

| | | | |
|--|----------|------------|---------------|
| | 1 | 2001 | 6 |
| | | 2006 | 1 |
| | 2 | | |
| | 200 | 1 | 200 17 |
| | 3 | | 2015 |
| | 11 | | |
| | | 2015 | 131 |
| | 1 | | |
| | | | 1 |
| | | 201 | |
| | | 51.4 | |
| | | 2020 | 2 |
| | | 2020-32135 | -24-03-512161 |
| | 2 | | |
| | 2015 | 131 | |
| | | | |
| | | 1 | |
| | 3 | | |

| | |
|--|--|
| | <p style="text-align: right;">2006 1</p> <p style="text-align: right;">1</p> <p style="text-align: center;">2006 1</p> <p style="text-align: center;">200 1</p> <p style="text-align: right;">200 17</p> |
| | <p style="text-align: left;">1</p> <p style="text-align: left;">1</p> <p style="text-align: right;">1</p> <p style="text-align: right;">201 74</p> |

| | | | | | | |
|----|----|-------------------------------|--|--|------|------|
| | | 1-1 | | | | |
| | | 1-1 | | | | |
| | | | | | | |
| | | 11 43 3 34 04 21 1000 1000 | | | | |
| | | | | | | |
| | | | | | | |
| | | 500 | | | 100 | |
| | | | | | 2000 | 13.5 |
| | | | | | 100 | 7.5 |
| | | 2000 1000 | | | | |
| | | 100 | | | | |
| | | 11 43 2 34 03 40 1000 1000 | | | | |
| | | | | | | |
| | | | | | | |
| | | 500 | | | 100 | |
| | | | | | 2000 | 14.7 |
| | | | | | 100 | .6 |
| | | 2000 1000 | | | | |
| | | 100 | | | | |
| | | | | | 1 | |
| | | | | | | 7.5 |
| | .6 | | | | | |
| | | | | | | 201 |
| 74 | | | | | | |
| | 2 | | | | | |
| | | | | | 2020 | 1 |
| | | 15 | | | | |

| | | | | | | |
|--|---|------------|--|--------|-----|--------|
| | | 15 | | | | |
| | | 1 | | | 7.1 | |
| | | 1-2 | | | | |
| | | 1-2 | | | | |
| | | | | | | |
| | | | | | | |
| | | | | | 7.1 | |
| | | | | | | |
| | | | | 7.1 | | |
| | | | | | | |
| | | 2020 1 | | | | |
| | 3 | | | | | |
| | | | | | | |
| | | | | 2020 4 | | 1-3 |
| | | | | | | |
| | | 1-3 | | | | |
| | | | | | | |
| | | | | | | |
| | | | | 2020 1 | | |
| | | 201 74 | | | | |
| | | | | | | |
| | | | | | | |
| | | " | | " | | 2020 4 |
| | | | | | | |
| | | | | | | |
| | | | | 1 | | |
| | | | | | | |
| | | | | " | | |
| | | | | " | | |

| | | | | | |
|--|--------|--------|--------|-------------|------------|
| | | | | | |
| | | 2020 | | | |
| | 14 .6 | 1.2 | 11. | 66. 2 .2 | 5.4 2.7 |
| | | | | , | |
| | | | 2020 | | |
| | | 524.15 | | | |
| | | | 2020 | | |
| | | 70% | | | |
| | | | 2020 | | 0% |
| | | 456. 7 | 2020 | | |
| | 3 0.67 | | | | |
| | | | | | |
| | | 2020 1 | | | |
| | 201 | 74 | | | |
| | | | 2020 4 | | |
| | 2 | | | | |
| | 201 | | | 201 | |
| | 2 | | 2 | | 3 |
| | | 10 | 2.5 | | |

10 2.5

2020

201

3 3 -2002

30 6-200 3

3

1

2.02 ^{3/}

15.4

4

2015 131

1

1

2015 131

1-4

>

<

[2020]78

| | | |
|--|--|--------|
| | | |
| | | |
| | | 4061 / |
| | | 1025 / |
| | | 546 / |
| | | |

| | | | |
|--|----------|--------|----------------|
| | | | |
| | 1 | 2 | 3 4 |
| | | |))) |
| | | | (2013 (2013 |
| | | | 1 |
| | | 2006 1 | |
| | | 200 1 | |
| | | | 200 17 |
| | 1 | 2020 | |
| | [2020]33 | | |
| | | 2020 | 2020 33 |

1-5

1-5 **2020**

2020 7 1

1

| | | | | |
|--|---|------|--|--|
| | | 7 15 | | |
| | 5 | 7 15 | | |
| | 6 | | | |

| | | |
|--|------------|---|
| | | |
| | 3 | |
| | | |
| | 1-7 | |
| | 1-7 | |
| | | |
| | | |
| | | |
| | 1 | |
| | 2 | |
| | 1 | |
| | 3 | |
| | | 1 |
| | 4 | |
| | | |
| | 1 | |
| | 2 | |

| | | | | | |
|--|--------|-------------|------------|--------|--------|
| | | | | | |
| | 1. | | | | |
| | 2.2020 | | | | |
| | 11. | 66. 2 .2 | 5.4 2.7 | 14 .6 | 1.2 |
| | 1. | | | | |
| | 2. | | | | |
| | 3. | | | | |
| | 4. | | | | |
| | 1. | 524.15 | | 2020 | 1. |
| | | 2020 | | | 70% |
| | | 0% | | | |
| | 2. | 456. 7 | 2020 | | 3 0.67 |
| | 3. | | | | 2. |
| | | | | | 3. |
| | | | | 2020 4 | |

| | | | |
|---|------|-----|----|
| 5 2018 122 1-9 | | | |
| | | | |
| 1 | | | |
| 2 | | 201 | |
| | | | |
| | | | |
| 3 | | | |
| 6 | 2020 | | |
| 4 | | | |
| 5 | 45 | 201 | 15 |
| 6 | | | |

| | | | | | | | | |
|-------------|---|------|------|------|------|--|-----|---------------|
| | | | | 0% | | | | |
| | | | | 0% | | | | |
| | 7 | | | | | | | ([2017]124) |
| 1-10 | | | | | | | | |
| | | | | | | | | |
| | | | | 2011 | 2013 | | | |
| | | 2011 | 2013 | | | | 201 | |
| | | 2013 | | | | | | |
| | | | | | | | | |

| | | | |
|----------|--|-------------|--|
| | | 1 1 -2002 1 | |
| 8 | | 2018 | |

9

| | | | |
|--|--|--------------|---------------------------|
| | | 32/ 3500 201 | |
| | | 37 22-201 | |
| | | 37 22-201 | 37 22-201 32/4041-2021 |
| | | 2000 | 2000 |
| | | | 1000 |

| | | | |
|--|-----------|------------------|-----------------|
| | | | |
| | 10 | [2014]128 | 2014 12 |
| | 15 | | |
| | 11 | | [2019]53 |
| | 1 | | |
| | | 2 | |
| | | | 3 |

| | | |
|--|-----|-----|
| | | 3 / |
| | 2 / | 0% |
| | + | 0% |

1

201 6

1

2021

2021 6

10000

600

600

2021

2 2

1

2

3

4

1

| | | | | | | |
|------------|---|-------|---------------------|-------|------------------|-----------|
| | | 2# | 042.11 ² | 4 | 250 | |
| | | | | | 160 ² | / |
| | | | | | | / |
| | | | | | 606 / | |
| | | | | | 4 0 / | |
| | | | | | 10 / | |
| | | | | | 500 ² | |
| | | | | | 15 1# | |
| | | | | | | |
| | | | | | 10 ² | |
| | | | | | 10 ² | |
| 3 | | | | | | |
| 2-2 | | | | | | |
| | | | | | | h |
| 1 | 6 | | 0 | 600 / | +600 / | *300 2400 |
| 1 | | | 600 / | 600 / | 0 | |
| 4 | | | | | | |
| 2-3 | | | | | | |
| | | | | / | / | |
| 1 | | -5545 | | 0 | 6 | +6 |
| 2 | | -5030 | | 0 | 6 | +6 |
| 3 | | 3 | | 0 | 6 | +6 |
| 4 | | / | | 0 | 6 | +6 |

| | | | | | |
|----|--|------------------|---|----|-----|
| 5 | | 16 | 3 | 3 | 0 |
| 6 | | -250 | 1 | 1 | 0 |
| 7 | | 1600 | 0 | 15 | +15 |
| | | 1200 | 0 | 15 | +15 |
| | | 100 | 0 | 1 | +1 |
| 10 | | 50 | 0 | 1 | +1 |
| 11 | | 00 | 0 | 1 | +1 |
| 12 | | 50 | 0 | 1 | +1 |
| 13 | | -30 | 0 | 1 | +1 |
| 14 | | $\frac{10}{7.5}$ | 0 | 1 | +1 |

5

1

2-4

| | | /a | /a | /a | | | |
|---|--|---------------------|---------------------|-------|--|--|------|
| 1 | | 0 | 300 | +300 | | | 25 / |
| 2 | | 0 | 50 | +50 | | | 25 / |
| 3 | | 0 | 10 | +10 | | | 25 / |
| 4 | | 0 | 0.01 | +0.01 | | | 1 / |
| 5 | | 10000 ^{3/} | 10000 ^{3/} | 0 | | | / |
| 6 | | 500 ^{3/} | 500 ^{3/} | 0 | | | / |
| 7 | | 5 | 10 | +5 | | | / |

| | | | | | | | | | |
|--|-----------------|-------|-------|-------|--------|--------|----------|--------|--|
| | 0. 0 0. 1 | | | | | | | | |
| | 170 | | | | 150 | | | | |
| | () | | | | | | | | |
| | ° | | | | | | | | |
| | () " | | | | | | | | |
| | " | " | " | | | | | " | |
| | 6 | | | | | | | | |
| | 30 | | | | 300 | | | | |
| | 50 / * | | | | 450 / | | | | |
| | 0. | 360 / | | | | | | | |
| | 5 ^{3/} | | | | | | | | |
| | 6. ³ | | | | | | | | |
| | / 50102-2014 | | | | | | | | |
| | 2-5 | | | | | | | | |
| | 2-5 | | | | | | | | |
| | 3/h | | | | | | | | |
| | 5 | 15 | 40 | | 25 | | % | | |
| | | | -10 | 0 | 10 | 20 | 30 | 40 | |
| | 1/ | | 0.000 | 0.001 | 0.0012 | 0.0014 | 0.0015 | 0.0016 | |
| | 0.0016 | | | | | | | | |
| | 0.1 | | | | | | | | |
| | 1.2 | | | | | | | | |
| | 0.05 | | | | | | | | |
| | 0. | | | | | | | | |
| | 1 | | | | | | | | |

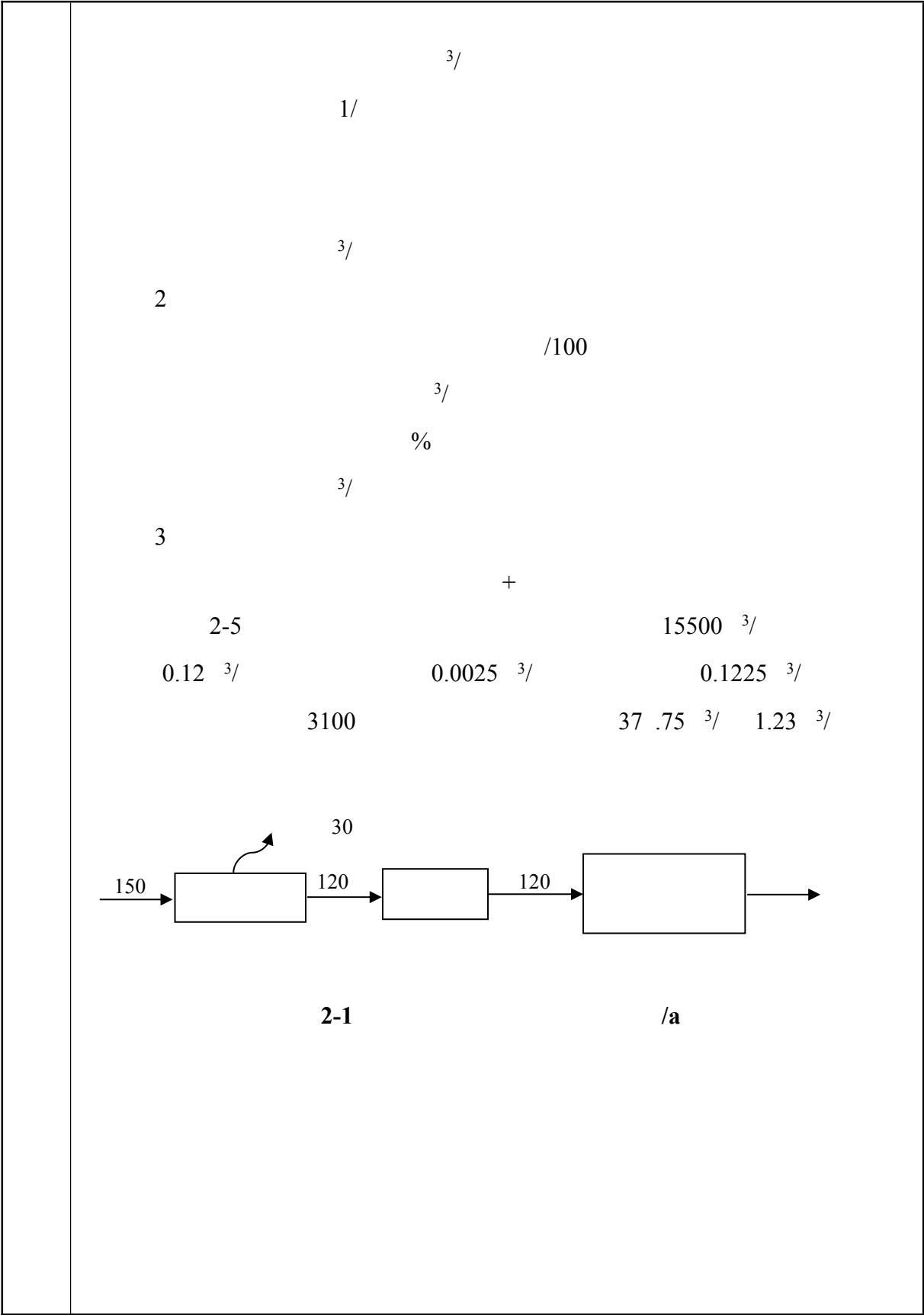

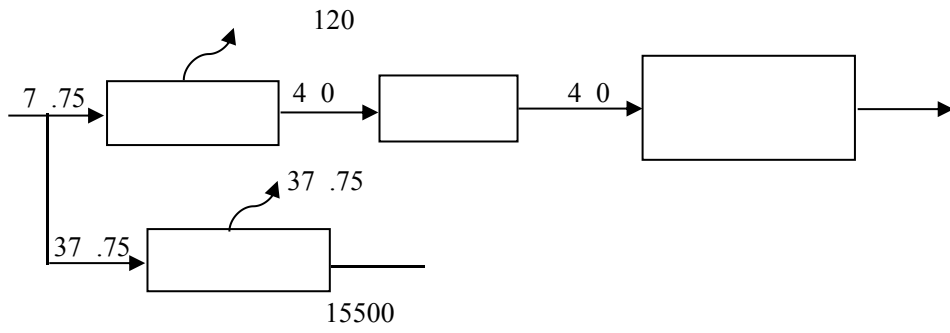

2-2

/a

7

10

/

15.

4

/

2.75 /

7.75 /

360 /

40 /

1000²

8

30

10

40

300

9

2

()

1

2

()

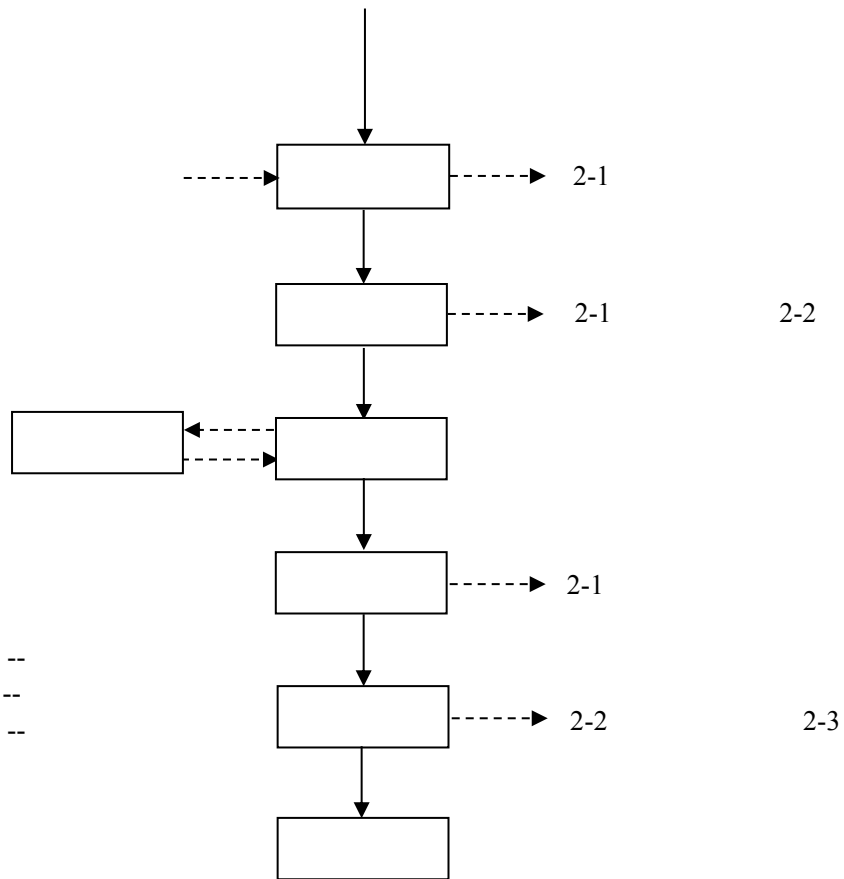

2-3

150-220

| | | | | | | |
|--|----------|---|-------------|-----|---|----------|
| | | | | 1 | 1 | 2 |
| | 1 | | | | | 3 |
| | 1 | | | 201 | 6 | |
| | | 1 | | | | 2021 |
| | 2 | | | | | |
| | | | 1-14 | | | |
| | | | 1-14 | | | |
| | | | | | | |
| | | | | | | |
| | | / | / | / | / | |
| | | | | | | |
| | 3 | | | | | |
| | | | 1-15 | | | |
| | | | 1-15 | | | |
| | | | | | | |
| | | | | | | h |
| | | | | 600 | / | 2400 |
| | 4 | | | | | |
| | | | 1-1 | | | |

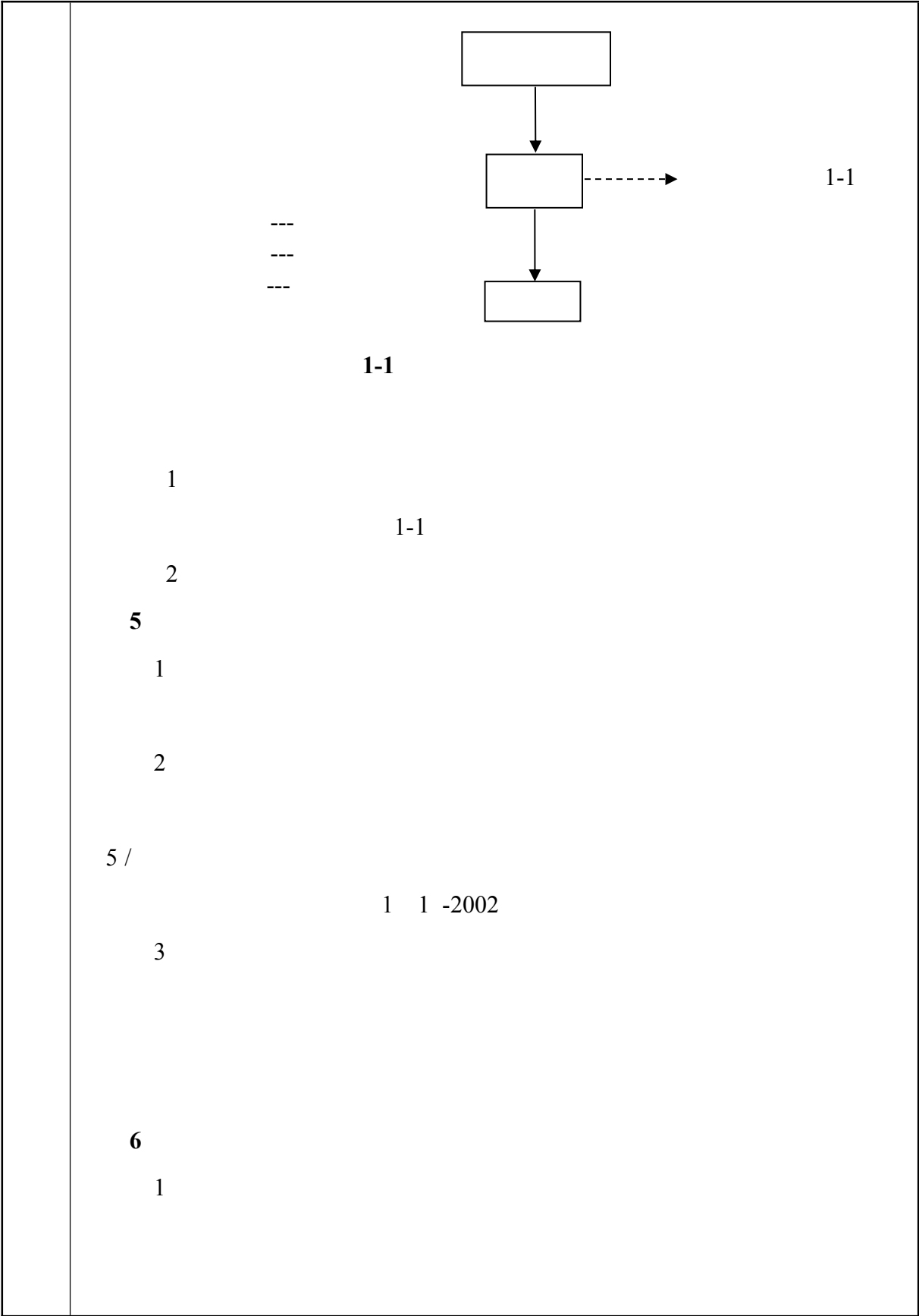

1 1 -2002

1-2

30

1-2

/a

2021 4

2021- -0336

1-16

| 1-16 | | 1 | | |
|------------|---|---|------|---|
| | | | | |
| 2021.04.14 | 1 | | .36 | |
| | | | 162 | / |
| | | | 0 | / |
| | | | 2 .4 | / |
| | | | 3. 6 | / |

7 -1 6

/ 31 62-2015) 1

4

2

| | | | |
|-------------------------------------|---|--------------|-------------|
| 1234 -200 3 | | | |
| 2021- -0336 | | | |
| 1-20 | | | |
| 1-20 | | | |
| | | dB(A) | |
| | | 2021 | 4 14 |
| | | | |
| 1 | 1 | 57 | 46 |
| | 1 | 55 | 47 |
| 3 | 1 | 55 | 46 |
| 4 | 1 | 56 | 47 |
| | | 65 | 55 |
| | | | |
| | | 1. / 2.2 / | |
| 1234 -200 3 | | | |
| | | 65 | 55 |
| 7 | | | |
| 1 | | | |
| 120 ^{3/} 0.4 ^{3/} | | 2021- -0336 | |
| | | 162 / | 0 / |
| | | 3- 2 .4 / | |
| 3. 6 / | | 0.01 4/ | 0.00 6 / |
| 3- 0.0034 / 0.0005 / | | | |
| 2 | | | |
| 1-21 | | | |

| 1-21 | | | | |
|-------------|---|-----------|--|-------|
| | | /a | | |
| 1 | | 1.2 | | |
| 2 | | 1.5 | | |
| 8 | | | | |
| | 1 | | | |
| | 1 | | | 7 122 |
| 9 | | | | |

- (2.2-201)

(30 5-2012)

3-3

3-3

g/ ³

| | | g/ ³ | |
|---|------------|-----------------|------|
| 1 | 2020.10.0 | 02 00 | 0.5 |
| | | 0 00 | 0.57 |
| | | 14 00 | 0.55 |
| | | 20 00 | 0.64 |
| | 2020.10.10 | 02 00 | 0.5 |
| | | 0 00 | 0.62 |
| | | 14 00 | 0.64 |
| | | 20 00 | 0.56 |
| | 2020.10.11 | 02 00 | 0.63 |
| | | 0 00 | 0.53 |
| | | 14 00 | 0.5 |
| | | 20 00 | 0.65 |
| | 2020.10.12 | 02 00 | 0.65 |
| | | 0 00 | 0.56 |
| | | 14 00 | 0.5 |
| | | 20 00 | 0.52 |
| | 2020.10.13 | 02 00 | 0.65 |
| | | 0 00 | 0.5 |
| | | 14 00 | 0.5 |
| | | 20 00 | 0.74 |
| | 2020.10.14 | 02 00 | 0.63 |
| | | 0 00 | 0.60 |
| | | 14 00 | 0.6 |
| | | 20 00 | 0.65 |
| | 2020.10.15 | 02 00 | 0.65 |
| | | 0 00 | 0.72 |
| | | 14 00 | 0.62 |
| | | 20 00 | 0.67 |

3-3

g/ ³

| | | g/ ³ | | % | % | |
|---|--|-----------------|-----------|------|---|--|
| 1 | | 2000 | 0.52-0.74 | 0.37 | 0 | |

| | | | | | |
|--|-------|------|-------|-------|-------------|
| | | | | - | (2.2-201) |
| | | 2021 | | | |
| | 2021 | 5 | 2021 | 2.5 | 43 / |
| | | | 74.2% | 4.5 / | |
| | | | | | 2020 |
| | % | 10% | 2. % | | |
| | | | | | |
| | 2.5 | | | | |
| | 3 | | | | |
| | 4 | | | | |
| | 5 | | | | |
| | 6 | | | | |
| | 7 | | | | |
| | | | | | |
| | 2 | | | | |

3 3 -2002

2017-201

3-4

3-4

g/ , H

| | | H | DO | COD | COD _M | | | | | | | LAS |
|--|------|------|------|-----|------------------|--------|------|-------|-------|-------|-------|-----|
| | 2017 | 7.36 | 4. | 1 | 4.4 | 0.002 | 1.23 | 0.236 | 0.035 | 0.006 | | |
| | 201 | 7.2 | 5.3 | 21 | 4. | 0.002 | 1.3 | 0.23 | 0.04 | 0.004 | 0.03 | |
| | 201 | 7.31 | 6.52 | 20 | 5.1 | 0.0016 | 1.32 | 0.21 | 0.04 | 0.006 | 0.0 3 | |
| | 2017 | 7.35 | 5.05 | 1 | 4.2 | 0.0022 | 0. 6 | 0.1 | 0.04 | 0.006 | 0.02 | |
| | 201 | 7.47 | 5. 6 | 21 | 4.7 | 0.0021 | 0. 2 | 0.21 | 0.04 | 0.005 | 0.03 | |
| | 201 | 7.21 | 6. 0 | 20 | 4.7 | 0.0017 | 1.14 | 0.1 | 0.04 | 0.005 | 0.0 | |
| | | 6 | 3 | 30 | 10 | 0.01 | 1.5 | 0.3 | 0.5 | 0.05 | 0.3 | |

ND

LAS

0.05 g/ ³

3

30 6-200 3

201

54. ()

10 61. () 50 51.4 ()

0 47.7 ()

30 6-200

3

1

500

3-5

3-5

| | | | | | | | |
|--|---|---|--|--|--|--|--|
| | / | | | | | | |
| | X | Y | | | | | |

| | | | | | | | | |
|--------------|--|------------------------|------------|------|------------------------|-----------------|--|------------|
| | | 666726.50 | 34.0 660 | | | | | 15 |
| UTM | | | | | | | | |
| 3-6 | | | | | | | | |
| | | | | | | | | |
| | | | | 6 40 | | | | 3 3 -2002 |
| | | | | 15 | 450 | | | 30 6-200 2 |
| | | | | 7100 | 6 .34 | | | |
| 1 | | | | | | | | |
| 31572-2015 5 | | | | | | | | |
| 37 22-201 | | | | | | | | |
| 31572-2015 | | | | | | | | |
| 14554- 3 1 | | | | | | | | |
| 2 3-7 3- | | | | | | | | |
| 3-7 | | | | | | | | |
| | | | | | | | | |
| | | g/ ³ | g/h | | g/ ³ | | | |
| 1 | | 60 | 1.2 | 15 | 4.0 | 31572-2015 5 | | |
| 2 | | 2000 | | 15 | 60 | (14554- 3) 1 2 | | |
| 3-8 | | | | | | | | |
| | | | | | | | | |
| | | g/ ³ | | | | | | |
| | | 6 | | | 1 | | | |
| | | 20 | | | | | | |
| 2 | | | | | | | | |

7 - 6 4
/ 31 62-2015 1

1 1 -2002 1

3-

| 3-9 | | g/L | H |
|------------|-----|--------------|----------|
| | | | |
| | 6- | | 6- |
| | 500 | | 50 |
| | 400 | | 10 |
| | 35 | | 5 |
| | | | 0.5 |
| | 70 | | 15 |
| | | 7 -1 6 4 | |
| | | / 31 62-2015 | 1 |
| | | 1 1 -2002 | 1 |

3

1234 -200 3

3-10

3-10

GB12348-2008

| | dB(A) | dB(A) |
|---|--------------|--------------|
| 3 | 65 | 55 |

4

1 5 -2020

1 5 7-2001

2013 36

2000 120

2010 61

| 3-11 | | | | /a | | | | | |
|-------|----|--------|---------|-------|-------|--------|--------|---------|---------|
| | | 1# | | 0.74 | 0.77 | - | 0.07 | | |
| | | | | 0.07 | 0 | - | 0.07 | | |
| | | | | 360 | 0 | 360 | 360 | | |
| | | | | 0.144 | 0.126 | 0.10 | 0.01 | | |
| | | | | 0.10 | 0.104 | 0.072 | 0.004 | | |
| | | | | 0.00 | 0.007 | 0.00 | 0.002 | | |
| | | | | 0.001 | 0.000 | 0.001 | 0.0002 | | |
| | | | | 0.011 | 0.006 | 0.011 | 0.005 | | |
| | | | | 3.6 | 3.6 | 0 | 0 | | |
| | | | | 4.37 | 4.37 | 0 | 0 | | |
| 3.12 | | | | /a | | | | | |
| | | | | | | | * | | |
| | | | | | | | | * | |
| | | 0 | 0 | 0.74 | 0.77 | 0.07 | 0 | 0.07 | +0.07 |
| | | 0 | 0 | 0.07 | 0 | 0.07 | 0 | 0.07 | +0.07 |
| | | 120 | 120 | 360 | 0 | 360 | 0 | 40 | +0.01 |
| | | 0.036 | 0.006 | 0.144 | 0.126 | 0.01 | 0 | 0.024 | +0.004 |
| | | 0.024 | 0.001 | 0.10 | 0.104 | 0.004 | 0 | 0.005 | +0.002 |
| | 3- | 0.003 | 0.0006 | 0.00 | 0.007 | 0.002 | 0 | 0.0026 | +0.0002 |
| | | 0.0004 | 0.00006 | 0.001 | 0.000 | 0.0002 | 0 | 0.00026 | +0.005 |
| | | 0.003 | 0.001 | 0.011 | 0.006 | 0.005 | 0 | 0.006 | +0.01 |
| | | 0 | 0 | 3.6 | 3.6 | 0 | 0 | 0 | 0 |
| | | 0 | 0 | 4.37 | 4.37 | 0 | 0 | 0 | 0 |
| 0.07/ | | | | 0.07/ | | | | | |

| | | | | | | |
|----------|---------|----|---------|---------|---------|------------|
| 2014 14 | | | | | | |
| 2 | | | 1.5 | | | |
| | | | 360 / | | | |
| 0.10 / | 0.072 / | 3- | 0.00 / | 0.001 / | 0.011 / | |
| | 0.01 / | | 0.004 / | 3- | 0.002 / | 0.0002 / |
| 0.005 / | | | | | | |
| | | | | | | |
| 0.0 7 / | | | | 0.0 7 / | | |
| 2014 14 | | | | | | |
| 2 | | | 1.5 | | | |
| | | | | 4 0 / | | |
| | 0.144 / | | 0.0 6 / | 3- | 0.012 / | 0.0014 / |
| 0.014 / | | | 0.024 / | | 0.005 / | 3- 0.002 / |
| 0.0002 / | 0.007 / | | | | | |

| | | | | | | | | | | | |
|--|--------------------|--|---------------------------------|-------|------|--|-----|---------------------------------|-------|------|-----|
| <p>1</p> <p>4-1</p> <p>4-1</p> | | | | | | | | | | | |
| | (³ /h) | | (^g / ³) | (g/h) | (/a) | | (%) | (^g / ³) | (g/h) | /a | () |
| 1# | 5000 | | 72.33 | 0.364 | 0.74 | | 0 | 7.23 | 0.036 | 0.07 | 15 |
| <p>2-1</p> <p>1 0 200</p> <p>360.1 /</p> <p>2 2</p> <p>1</p> <p>0.71 /</p> <p>2.70 / -</p> <p>2400</p> | | | | | | | | | | | |

| | | | | | | | |
|----------|---|------|---------------------|------------|---------|----------------|------------|
| | | | | | | | |
| | + | | | | | | 0% |
| | | 0% | 5000 ³ / | 15 | | | |
| | | | 0.74/ | | 72.33 | / ³ | |
| 0.364 | / | | | | | | 0.07/ |
| | | 7.23 | / ³ | 0.036 | / | | |
| | | | | | | 31572-2015 | 5 |
| 2 | | | | | | | |
| | | | | 4-2 | | | |
| | | | 4-2 | | | | |
| | | | / | | | | |
| | | | /a | | | | g/h |
| | | | 0.07 | | 20 | 45 | 0.0405 |
| | | | | | | | |
| | | | | | | | 10% |
| | | | | 0.07/ | | | 0.0405/ |
| | | | | | | | 31572-2015 |
| 5 | | | | | | | |
| | | 37 | 22-201 | | | | |
| | | | | 31572-2015 | | | |
| 3 | | | | | | | |
| | | | - | | 2.2-201 | | |
| | | | | | | | 50% |
| | | | | | | | |
| | | | | 4-3 | | | |

4-3

500 1 10-10
700 2300 ^{2/}

50

0%

0%

4-2

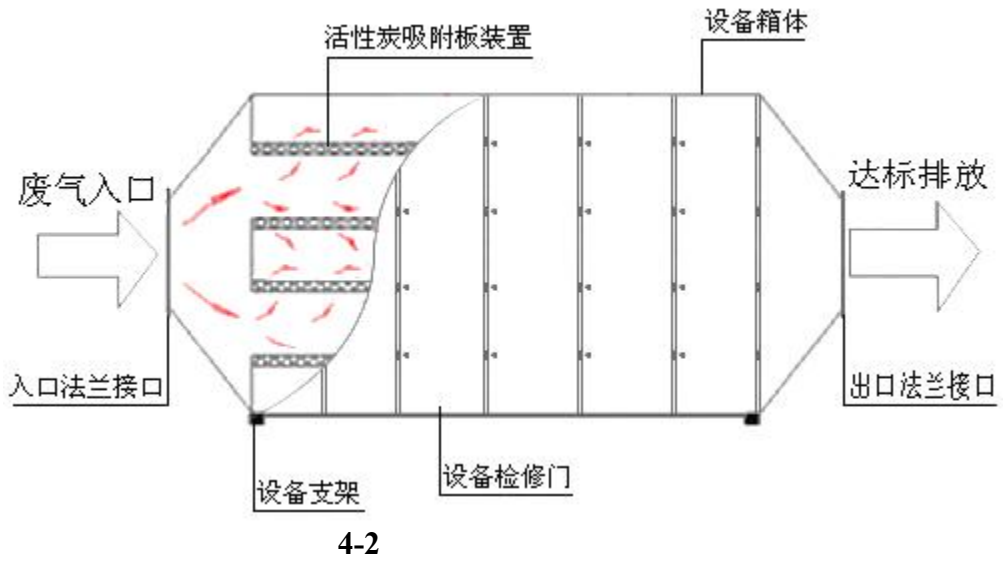

4-4

| | |
|-------------------------|-------------|
| | 5000 |
| ^{3/h} | 300*250*100 |
| | 12 40 |
| c ^{3/g} | 0. 1 |
| | 5% |
| (^{2/g}) | 1000 1500 |
| | 10 |
| | 1 |

| g | 30 |
|------|-------|
| | 0.3 / |
| 1100 | |
| 2 | |

4-5

4-5

| | | g/ ³ | g/h | g/ ³ | g/h | |
|----------|----|-----------------|------|-----------------|-------|-----|
| 201 .1.5 | 01 | .2 | 0.14 | 0. | 0.013 | 0.7 |
| | | .06 | 0.14 | 0. | 0.013 | 0.7 |
| | | .64 | 0.15 | 0. 6 | 0.013 | 1.3 |
| 201 .1.6 | 01 | .66 | 0.15 | 0. 4 | 0.012 | 2 |
| | | .11 | 0.14 | 0. 7 | 0.013 | 0.7 |
| | | .45 | 0.15 | 0. 5 | 0.013 | 1.3 |

0%

5

1

4-6

4-6

| | | | | |
|--|--|------|----------------|--|
| | | | | |
| | | 2000 | / ³ | |

- (2.2-201) 5.3

- 2.2-201

4-7

4-7

| | | | |
|--|--|----|-----|
| | | | |
| | | | 10% |
| | | 1% | 10% |
| | | | 1% |

| | | | | | | | | | | | |
|------------|---|----------|-------|--|-----|-----|-----|-----|--------|--------|-------------|
| | 10% | | | | | | | | 10% | | |
| | $P_i = \frac{C_i}{C_{0i}} \times 100\%$ | | | | | | | | | | |
| | % | | | | | | | | | | |
| | / 3 | | | | | | | | | | |
| 0 | / 3 | | | | | | | | | | |
| 2 | 4- | | | | | | | | | | |
| 4-8 | | | | | | | | | | | |
| | () | | | | | | | | | | |
| | X | Y | | | () | () | () | () | (³/h) | | |
| 1# | 666 53.5 | 3772 | 0. 4 | | 0 | 15 | 0.5 | 20 | 5000 | | 0.03 6 / |
| 4-9 | | | | | | | | | | | |
| | () | | | | | | | | | | |
| | X | Y | | | () | () | () | | | | |
| | 672137.73 | 377 | 1 . 7 | | 0 | 45 | 20 | | | 0.0405 | / |
| 3 | 4-10 | | | | | | | | | | |
| / | | | | | | | | | | | |
| / | | | | | | | | | | | |
| 65000 | | | | | | | | | | | |
| 3 | | | | | | | | | | | |
| -1 | | | | | | | | | | | |
| / | | | | | | | | | | | |
| / | | | | | | | | | | | |

| | | |
|--|---|---|
| | / | / |
| | / | / |

10%

4-11

| | | |
|--|----|-----|
| | | |
| | | 10% |
| | 1% | 10% |
| | | 1% |

4-12

| | | | Kg/h | g/ 3 | Pi % | g/ 3 | D10%() |
|--|----|--|-------------|-------------|-------------|-------------|----------------|
| | 1# | | 0.036 | 2 | 0.13 | 0.001 74 | 0 |
| | | | 0.0405 | 2 | 1.35 | 0.0202 | 0 |

1.35%

0.0202 / 3

- 2.2-201 5.3

| | | | | | | | |
|---|--|--|--|-----------|------------|-----|-------|
| 1 | | | | | 31572-2015 | 4.0 | 0.0 7 |
| | | | | 0.0 7 | | | |
| 4-15 | | | | | | | |
| | | | | <i>/a</i> | | | |
| 1 | | | | | 0.1 4 | | |
| 6 | | | | | | | |
| | | | | - | 2.2-201 | | |
| <div style="display: flex; flex-direction: column; justify-content: center; align-items: center;"> <div style="margin-bottom: 20px;">31572-2015</div> <div style="margin-bottom: 20px;">7</div> <div style="margin-bottom: 20px;">/ 3 4 -2020</div> <div style="margin-bottom: 20px;"> $\frac{Q_c}{C_m} = \frac{1}{A}(BL^c + 0.25r^2)^{0.50} L^D$ </div> <div style="margin-bottom: 20px;">-- / 3</div> <div style="margin-bottom: 20px;">-- /</div> <div style="margin-bottom: 20px;">--</div> <div style="margin-bottom: 20px;">--</div> <div style="margin-bottom: 20px;">--</div> <div style="margin-bottom: 20px;">/</div> </div> | | | | | | | |

| | | | | | | | | | | |
|--|---|-----|----|---|--|--|---|-----|---------------|-------------------------|
| | | | | | | | | | | |
| | | | | | | | | | | |
| | 1 | 001 | 1# | , | | | 4 | 1 / | 3 -2017 | 3157 2-201 5 5 |
| | | | | , | | | | | | |
| | | | | , | | | 4 | 1 / | 14675 / | 1455 4- 3 2 |
| | | | | , | | | | | | |
| | 2 | | / | , | | | 4 | 1 / | - 604-2017 | 3157 2-201 5 |
| | | | | , | | | | | | |
| | | | | , | | | 4 | 1 / | 14675 / | 1455 4- 3 1 |

9

31572-2015

5

15

37 22-201

31572-2015

1

30

300

50 / *

450 /

0.

360 /

2

5^{3/}

6.³

/ 50102-2014

4-1

4-19

| ^{3/h} | | | | | | | | % | |
|----------------|--------|--|----|-------|-------|--------|--------|--------|--------|
| | 5 | | 15 | 40 | | 25 | | | 0.05 |
| 1/ | | | | -10 | 0 | 10 | 20 | 30 | 40 |
| | 0.0016 | | | 0.000 | 0.001 | 0.0012 | 0.0014 | 0.0015 | 0.0016 |
| | | | | 0.1 | | 0.05 | | | |
| | | | | 1.2 | | 0. | | | |

| | | | |
|---|-------------|---------------|-----------|
| 1 | | 3/ | |
| | 1/ | | |
| | 3/ | | |
| 2 | | /100 | |
| | | 3/ | |
| | | % | |
| | 3/ | | |
| 3 | | + | |
| | 4-1 | | 15500 3/ |
| | 0.12 3/ | 0.0025 3/ | 0.1225 3/ |
| | 3100 | 37.75 3/ | 1.23 3/ |
| 2 | | | |
| 1 | | | /2.3-201 |
| | 4-20 | | |
| | 4-20 | | |
| | | Q/ 3/d | / |
| | | 20000 | 60000 |
| | | 200 | 6000 |
| | | | |
| | 600 / | | |

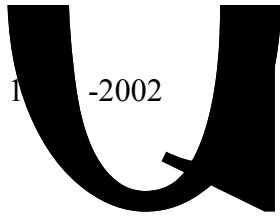

2

,200 ,27() 1155-1161

/

600 ^{3/}

2 ^{3/}

5 ^{3/}

300 /

200 /

3- 25 /

3 /

30 /

3

3

4.

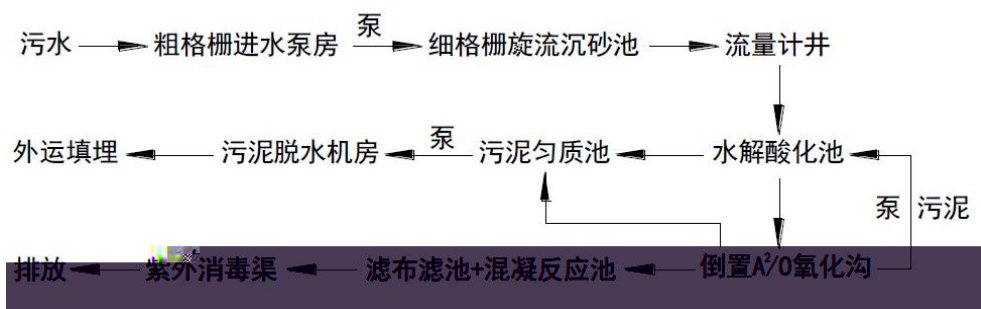

4-4

2/

2/

2/

2/

7. 3/

7 7. 3/

5.1 3/

4 0 3/ 1.6 3/

4-21

| /a | g/ L | /a | g/L | /a | g/L | /a |
|-----------|-----------------|-----------|------------|-----------|------------|-----------|
| | 400 | 0.144 | 300 | 0.10 | 50 | 0.01 |
| | 300 | 0.10 | 200 | 0.072 | 10 | 0.004 |
| | 25 | 0.00 | 25 | 0.00 | 5 | 0.002 |
| 360 | 3 | 0.001 | 3 | 0.001 | 0.5 | 0.0002 |
| | 30 | 0.011 | 30 | 0.011 | 15 | 0.005 |

| | /a | | | | | | | | | /a |
|-----|----|-----|--------|--|-----|--------|--|-----|---------|----|
| 4 0 | | 400 | 0.1 2 | | 300 | 0.144 | | 50 | 0.024 | |
| | | 300 | 0.144 | | 200 | 0.0 6 | | 10 | 0.005 | |
| | | 25 | 0.012 | | 25 | 0.012 | | 5 | 0.0026 | |
| | | 3 | 0.0014 | | 3 | 0.0014 | | 0.5 | 0.00026 | |
| | | 30 | 0.014 | | 30 | 0.014 | | 15 | 0.006 | |

4-23

| | | | | / | /a | | / | g/L |
|---|----|-------|-------|-----|----|--|---|-----|
| 1 | | | | | | | | 50 |
| 2 | | | | | | | | 10 |
| 3 | 00 | 11 | 34 0 | | | | | 5 |
| 4 | 1 | 4 '5 | 4'57. | 4 0 | / | | | 0.5 |
| 5 | | 0.42" | 11" | | | | | 15 |

| | | |
|-----------|------|---------------|
| | 3 | 4. |
| | | + 2/ |
| + | | 205 |
| | | |
| | | |
| | | 50000 3/ |
| | | 4 0 3/ 1.6 3/ |
| | | |
| 0.0032% | | |
| | | |
| | | |
| 4 | | |
| | | |
| 1 1 -2002 | | |
| | | |
| | | |
| | | |
| 5 | | |
| | | |
| | 4-25 | |

n "

1 1 -2002 1

3

70 0 ()

2.4-200

1

$$L_A(r) = L_A(r_0) - A$$

()

0 0 ()

2

()

$$L_{eqg} = 10 \lg \left(\frac{1}{T} \sum_i t_i 10^{0.1 L_{Ai}} \right)$$

()

()

3

()

$$L_{eq} = 10 \lg(10^{0.1L_{eqg}} + 10^{0.1L_{eqb}})$$

()

()

4

$$A_{div} = 20 \lg(r / r_0)$$

0

4-26

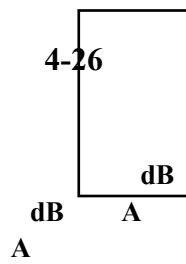

dB
A

dB
A

dB
A

dB
A

dB
A

| | | | | | | | | | | |
|--|--|----|----|----|----|-------|-------|------|----|-------|
| | | 1 | 0 | 25 | 45 | 33.06 | 24.5 | | | |
| | | 30 | 0 | 25 | 40 | 32.04 | 22.6 | | | |
| | | 1 | 0 | 25 | 50 | 33. | 24.03 | | | |
| | | 1 | 75 | 25 | 60 | 35.56 | 24.44 | | | |
| | | 1 | 75 | 25 | 55 | 34.1 | 15.1 | | | |
| | | 6 | 75 | 25 | 5 | 3.5 | 17.43 | 22.3 | 57 | 57.01 |
| | | 6 | 70 | 25 | 0 | 3.06 | .5 | | | |
| | | 1 | 0 | 25 | 0 | 3.0 | 1.3 | | | |
| | | 30 | 0 | 25 | 5 | 3.55 | 15.45 | | | |
| | | 1 | 0 | 25 | 5 | 3.5 | 1.42 | | | |
| | | 1 | 75 | 25 | 0 | 3.06 | 1.4 | | | |
| | | 1 | 75 | 25 | 0 | 3.0 | 10.2 | | | |
| | | 1 | 75 | 25 | 0 | 3.0 | 10.2 | | | |

57.01
1234 -200 3

5

4-27

| | | | | | | |
|--|-------|-------|--|--|--------------|--------------|
| | | | | | | |
| | | | | | dB(A) | dB(A) |
| | 0 -17 | 1 -21 | | | 65 | 55 |
| | | | | | | 1 / |

4

1

1

30

0.5

4.5 /

| | | | | | | |
|---|--|-------|-------|---|---|--|
| 2 | | 1.56 | 1.56 | | 0 | |
| 3 | | 4.3 7 | 4.3 7 | 0 | 0 | |
| 4 | | 6.0 | 6.0 | 0 | 0 | |

2

1

2

3. 6 / 4.3 7 /
10²

4.5 /

0.

250 4

0.4²

1.6²

10²

1 5 -2001

10²

4.3 7 /

4 1.462 100 4

15

0.4²

6²

10²

3

| | | | | | | | | | | |
|---------------------|--|--|---|-------------|-------|----|-------------|-------|---|--|
| 4-30 | | | | | | | | | | |
| 4-31 | | | | | 4-32 | | | | | |
| 4-30 | | | | | | | | | | |
| | | | | | | | | | / | |
| 1 | | | | | | 4 | 00-03 -4 | 4.3 7 | | |
| 2 | | | | | / | 14 | / | 5.6 | | |
| 3 | | | | | / | 10 | / | 0.36 | | |
| 4 | | | | | / | | / | 6.0 | | |
| 4-31 | | | | | | | | | | |
| | | | | | | | | | | |
| | | | | | /a | | | | | |
| 1 | | | 4 | 00-03 -4 | 4.3 7 | | | | | |
| GB18599-2001 | | | | | | | | | | |

1 5 7-2001

70

1 5 7-2001

10^{-7} / 2

2

1

10^{-10} /

4-32

| | | | | | | | | | |
|--|--|--|--|--|--|--|--|--|--|
| | | | | | | | | | |
|--|--|--|--|--|--|--|--|--|--|

| | | | | | | | | | | |
|-------------|--|--|--|---|----------|--|-----------------|--|-------|--|
| 1 | | | | 4 | 00-03 -4 | | 10 ² | | 1.462 | |
| 15562.2-1 5 | | | | | | | | | | |
| 4-33 | | | | | | | | | | |
| 4-33 | | | | | | | | | | |
| | | | | | | | | | | |
| | | | | | -01 | | | | | |
| | | | | | -02 | | | | | |
| 5 | | | | | | | | | | |
| 1 | | | | | | | | | | |
| () 64-201 | | | | | | | | | | |
| - | | | | | | | | | | |
| 43606.72 | | | | | | | | | | |
| 4-34 | | | | | | | | | | |
| 4-34 | | | | | | | | | | |
| | | | | | | | | | | |
| | | | | | | | | | | |
| | | | | | | | | | | |
| | | | | | | | | | | |
| | | | | | | | | | | |

2

610-2016 4.1

-116

-

3

4-35

4-35

| | | |
|--|--|--------------|
| | | |
| | | 10^{-10} / |
| | | 10^{-7} / |
| | | |

1 5 7-2001

4

6

1

7.5

7.1

1

4-36

4-36

| E | P | | | |
|---|----|----|----|----|
| | P1 | P2 | P3 | P4 |
| 1 | + | | | |
| 2 | | | | |
| 3 | | | | |
| + | | | | |

$$Q = \frac{q_1}{Q_1} + \frac{q_2}{Q_2} + \dots + \frac{q_n}{Q_n}$$

1 2

1 2

1

1

1 1

10

2

10

100

3

100

4-37

4-37

| | i | Qi | | i/Qi |
|--|----------|-----------|-----------|-------------|
| | 1.462 | 50 | / 16 -201 | 0.02 24 |
| | / | | / | 0.02 24 |

0.02 24

1

2

16 -201

4-36

4-38

| | IV IV⁺ | III | II | I |
|--|--------------------------|------------|-----------|----------|
| | | | | |

3

4

50140-2005

50016-2014

501 7- 3

1.1

| | | | | |
|--|----|----|--------------------------------|-----------------|
| | / | | | |
| | | | | 37 22-201 |
| | 1# | | 5000 ^{3/} + +15 | 31572-201 5 |
| | | 3- | 5 ³ | 1 1 -200 2 1 |
| | | / | | 1234 -200 3 |
| | / | | | |
| | | | | |
| | | | | |
| | / | | | |

32/ 37 5-2020

2015 224

1

2.

3

4

1

7 122





()



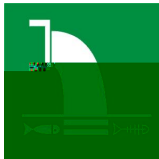

5-1

5-1

| | | | | | |
|--|-----|--|--|--|--|
| | | | | | |
| | -01 | | | | |
| | -02 | | | | |
| | 1# | | | | |
| | -01 | | | | |
| | -01 | | | | |
| | -02 | | | | |

5-2

| | | | | |
|---|---|---|--|--|
| | | | | |
| 1 |  |  | | |
| 2 |  |  | | |

| | | | | | |
|-----|---|---|---|------------|---|
| | 3 |  |  | | |
| | 4 |  |  | | |
| | 5 | / |  | | |
| 1 | | | | | |
| 2 | | | | | |
| 3 | | | | | |
| 4 | | | | | |
| 2 | | | | | |
| 5-3 | | | | | |
| 5-3 | | | | | |
| | | | | | |
| | | | 5000 ^{3/} + | 31572-2015 | 6 |
| | | | 5 ³ | 5 | / |

| | | | | | |
|--|--|--|-----------------|-------------|------------|
| | | | | 1234 -200 3 | 2 |
| | | | 10 ² | 1 5 -2001 | 1 |
| | | | 10 ² | 1 5 7-2001 | 1 |
| | | | | | / |
| | | | | | / |
| | | | | | / |
| | | | | | / |
| | | | 0.0 7 / | 0.0 7 / | |
| | | | | 2014 14 | 2 |
| | | | | 1.5 | |
| | | | | 360 / | |
| | | | | 0.10 / | 0.072 / |
| | | | 3- 0.00 / | 0.001 / | 0.011 / |
| | | | 0.01 / | 0.004 / | 3- 0.002 / |
| | | | 0.0002 / | 0.005 / | |
| | | | | 0.0 7 / | |
| | | | 0.0 7 / | | |
| | | | | 2014 14 | 2 |
| | | | | 1.5 | |
| | | | | 4 0 / | |
| | | | | 0.144 / | |
| | | | 0.0 6 / | 3- 0.012 / | 0.0014 / |
| | | | | 0.024 / | 0.005 / |
| | | | 0.002 / | 0.0002 / | 0.007 / |
| | | | | | / |

| | | | |
|--|----|----|---|
| | 50 | / | |
| | | 10 | / |

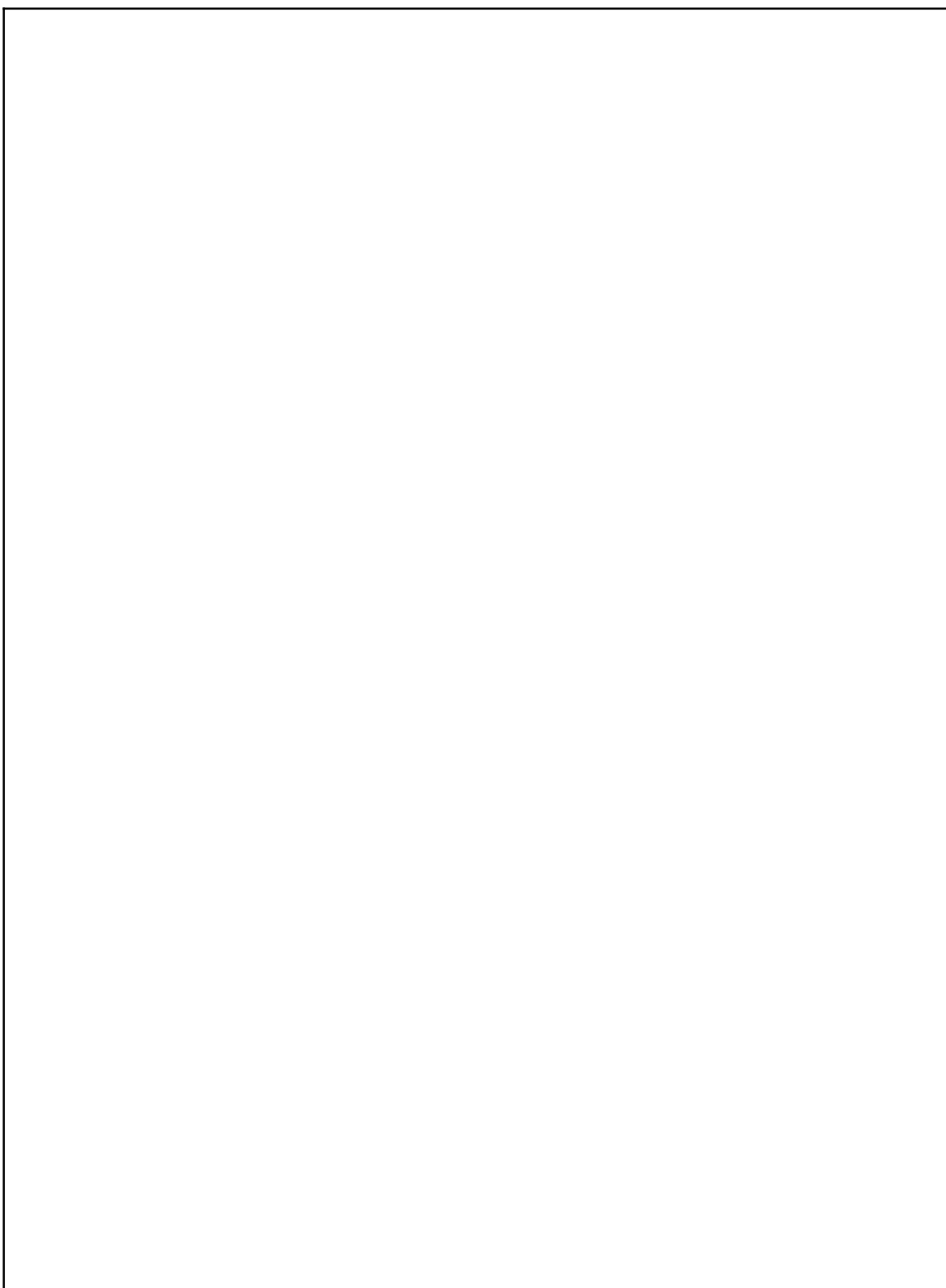

| | | | | | | | | |
|--|----|--------|---|---|-------|---|--------|--------|
| | | | | | | | | |
| | | 0 | 0 | 0 | 0.184 | 0 | 0.184 | +0.184 |
| | | 120 | 0 | 0 | 360 | 0 | 4 0 | +360 |
| | | 0.036 | 0 | 0 | 0.10 | 0 | 0.144 | +0.10 |
| | | 0.024 | 0 | 0 | 0.072 | 0 | 0.0 6 | +0.072 |
| | 3- | 0.003 | 0 | 0 | 0.00 | 0 | 0.012 | +0.00 |
| | | 0.0004 | 0 | 0 | 0.001 | 0 | 0.0014 | +0.001 |
| | | 0.003 | 0 | 0 | 0.011 | 0 | 0.014 | +0.011 |
| | | 1.5 | 0 | 0 | 4.5 | 0 | 6 | +4.5 |
| | | 1.2 | 0 | 0 | 0.36 | 0 | 1.56 | +0.36 |
| | | 0 | 0 | 0 | 5.6 | 0 | 5.6 | +5.6 |
| | | 0 | 0 | 0 | 4.3 7 | 0 | 4.3 7 | +4.3 7 |

+ + - -

1
2
3
4
5
6
7

10
11
12
13
14

1
2
3
4
5
6